

The ATIZ logo is located in the top left corner of the image. It consists of a red triangle followed by the letters 'ATIZ' in a bold, red, sans-serif font.

**ATIZ**



# BookDrive DIY

The Ultimate Book Scanning Solution.

[atiz.com](http://atiz.com)

A system that is designed to be gentle on books  
high quality scans quickly and efficiently.



while delivering curvature-free,





## What is BookDrive DIY?

BookDrive DIY is an innovative book digitization solution that combines the power of digital SLR cameras and the ingenuity of a unique v-shaped book cradle and transparent platen to capture sharp, curvature-free images at a rate of up to 700 pages per hour.

Put simply, BookDrive DIY is the most efficient, versatile and affordable scanning solution available today. Whether you are a small school, local library, university or imaging center, Atiz Innovation invites you to take a closer look.

## The Evolution of Scanners



### Flatbed scanners

- Face-down scanning on a flat base placing stress on bindings.
- Books must be lifted to turn pages.
- Books must be correctly positioned for every scan.
- Images are distorted near the page binding, characterized by a dark shaded region.

### Scan Results

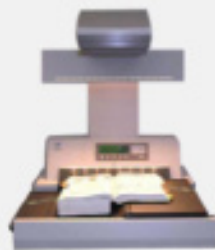

### Overhead scanners

- Face-up scanning. Books must be fully opened at 180.
- The center of the book (page binding) creeps from left to right as the pages are turned resulting in margin crawl.
- User must use fingers to flatten pages and keep them from flapping.
- Images suffer from curved text lines.

### Scan Results



### BookDrive DIY

- Face-up scanning. Books are partially opened on a v-shaped cradle.
- The cradle and platen keep pages flat and eliminate margin crawl.
- Further handling is not required.
- High-resolution digital SLR cameras capture sharp, curvature-free images.

### Scan Results

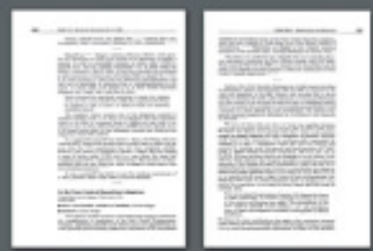

# Why BookDrive DIY?



## ✓ Versatility:

BookDrive DIY can be used to scan all kinds of books and can facilitate many different sizes, thicknesses and types of bindings. It is especially easy on frail old books.

## ✓ Curvature-free:

Overhead scanners produce images that suffer from curved text lines and rely on unreliable software for correction. However, BookDrive DIY natively produce sharp, curvature-free pages are captured every time.

## ✓ Face-up scanning:

Scanning is performed without laying books out flat and placing stress on bindings. Handling is kept to a minimum, as pages can be turned without having to flip the book over each time, saving you precious time.

## ✓ Auto-centering cradle:

The auto-centering, v-shaped cradle and transparent platen act to gently sandwich the book and correctly position it before each scan. This produces consistent borders and margins with every page.

## Superior OCR Accuracy. It's 300 fewer errors every page.

When performing an OCR on the images from BookDrive DIY vs. traditional scanners, you can see the mind-boggling difference between the BookDrive DIY and the competition. It's hundreds of errors fewer in every page!

Testing conducted on sample thick-spine books by Atiz in May 2008 using ABBYY FineReader Professional Version 8 as benchmark.

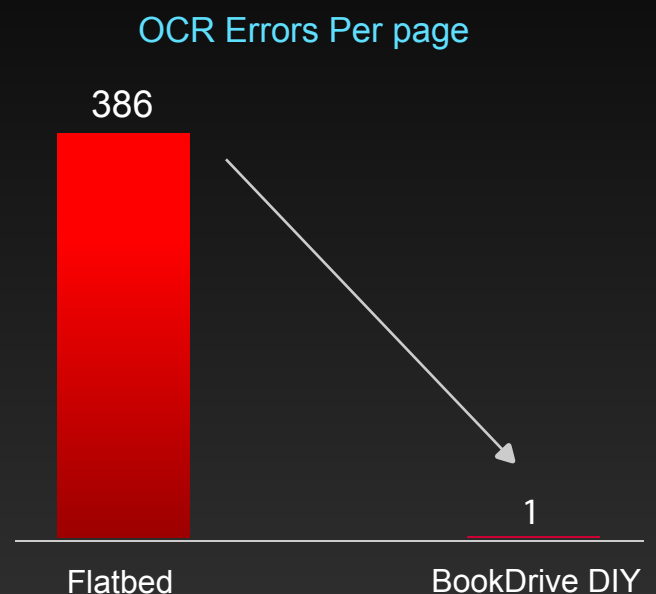

# BookDrive DIY Software



## BookDrive Capture

BookDrive Capture is the application that controls the cameras connected to your computer. It supports a wide range of models from Canon (see back page) and allows you to change camera settings from directly within the software.

Press one button and the system captures both left and right pages and have the images rendered on screen immediately.

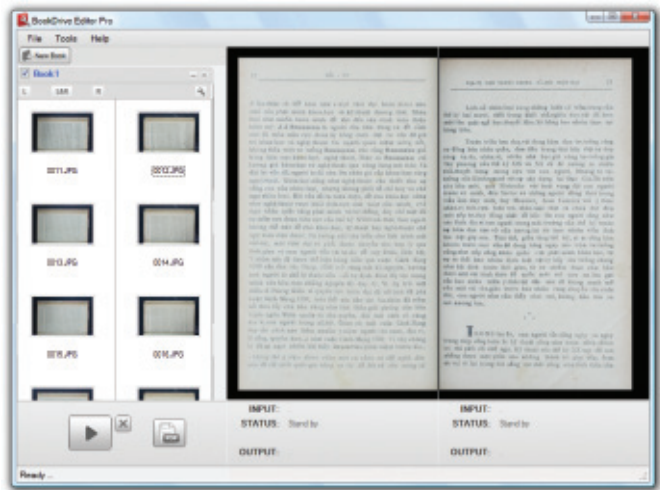

## Auto-Capture

Digitization can be an arduous task. Each time a page is to be scanned a button must be pressed. However, BookDrive DIY delivers ease of use with auto-capture features. Time-lapse mode in the software triggers the cameras to shoot at pre-defined intervals, requiring you to simply flick through the pages. Even better, you can add the optional AutoSwitch to trigger the cameras to shoot when the transparent platen is engaged. Suddenly, book scanning becomes a lot more convenient.



## BookDrive Editor Pro

BookDrive Editor is powerful image processing software for use with BookDrive DIY. The software can also be used to process images from other scanners. BookDrive Editor helps you produce images of the highest quality, ready for distribution and archiving. It combines robust image enhancement tools with an intuitive user interface to deliver professional results with minimal fuss.

### Highlights include:

- **Fast Batch Processing** - Scan the entire book and select the desired effects for the first left and right page images, then BookDrive Editor will automatically apply those settings to the remaining images for unattended, hassle-free operation.
- **Multi-chapter, multi-book operation** - Each book chapter may require different settings. BookDrive Editor allows you to create different settings for different chapters of a book, or for different books. You can have BookDrive Editor process all the images from various chapters and books in one single operation.
- **Book Profiling** - The software comes with recommended profiles for use with various kinds of books (textbook, magazines, etc.) This is to help novice users get started right away. You can also create and save custom profiles for use in subsequent jobs on books with similar attributes.
- **Background Removal:** Replaces an unwanted tinted page background common in old books with a bright and clear background free from speckles and stains.

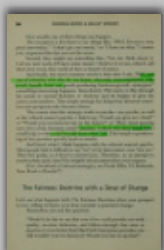

Original output



Processed output

- ✓ Good for preserving old, faded prints and priceless historical works.
- ✓ Color and highlights are still preserved while removing the tinted background.
- ✓ Gives new life to grey and drab pages such as newspapers.

- **Adaptive Local Thresholding for B&W Conversion** – An advanced algorithm that intelligently converts each pixel to black or white according to its brightness level relative to the surrounding area will retain greater detail compared to standard techniques.

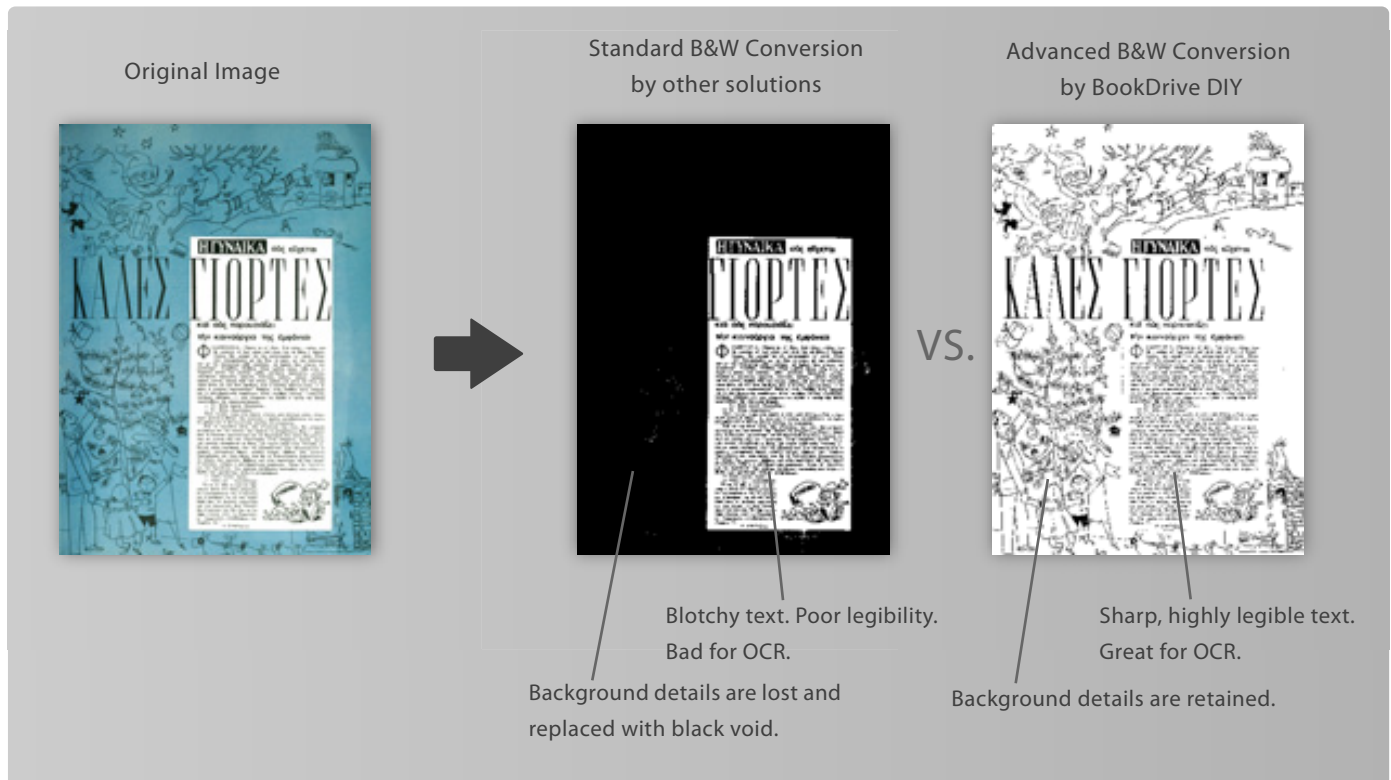

- **OCR Optimization** - Curvature-free images from BookDrive DIY generally results in OCR accuracy that is superior to bound document images from other scanners.
- **Other standard features** - Include rotation, de-skew, crop, auto level, brightness and contrast adjustment, sharpen, black border removal, image resize and DPI adjustment, etc.
- **Available output formats** - Include PDF (single-page file or multi-page file), TIFF (LZW and CCITT Group 4, single-page or multi-page file), and JPEG.

## Join the Atiz Community

Discover BookDrive DIY today and join the growing list of satisfied customers such as:

- American Museum of Natural History
- Princeton University
- Boston University
- University of California, Berkeley
- University of California, Los Angeles
- Los Angeles Public Library
- George Mason University
- City of Toronto
- Hampden Country Registry, Massachusetts
- University of North Texas
- Texas Transportation Archives
- Miami University of Ohio
- University of Nevada Reno
- Charles Darwin University, Australia
- State Library of Tasmania, Australia
- Victoria University of Wellington, New Zealand
- National Library of Singapore
- National Pedagogic Museum of Ukraine
- National Library of Iran
- Malaysia's Agricultural Research & Development Institute
- Ankara University, Turkey
- Government of Suriname
- Office of His Majesty's Principal Private Secretary, Thailand
- Chulalongkorn University, Thailand

Learn more about Atiz Innovation and everything that is digitization by visiting us online at [www.atiz.com](http://www.atiz.com) and become part of the Atiz Community. Our growing network of engineers, developers and user are waiting to answer all your questions.

## Size and weight of the unit

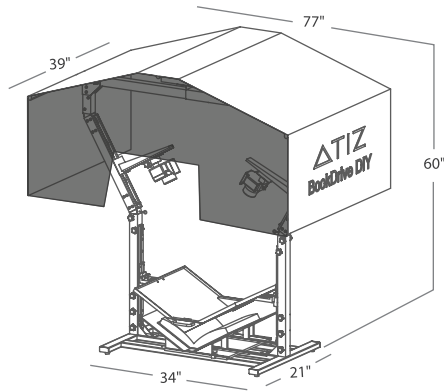

Height: **60** inches (152 cm)  
Width: **34** inches (86 cm)  
Depth: **21** inches (53 cm)  
Weight: **77** pounds (35 kg)

## Supported book size



### Model B - Extra Large Format

maximum scanning area: 15.5"x24"  
approximately A2 paper

## Size and weight of the box

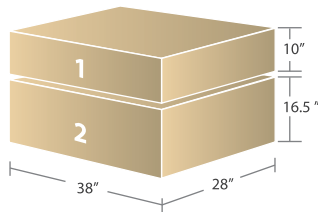

BookDrive DIY (base set) is shipped in 2 carton boxes.

Box 1 weight: **61** pounds (28 kg)  
Box 2 weight: **33** pounds (15 kg)

## Software

- BookDrive Capture
- BookDrive Editor Pro
- Requirements
  - Windows Vista (32 bit system) or Windows XP
  - 64 bit system is not supported
  - Requires 2 computers (for Dual PC mode, capturing left and right images simultaneously) if the operating system is Vista
  - CPU 1GHz or higher
  - RAM 1GB minimum
  - 10GB available disk space
  - 1024 x 768 resolution monitor

## What's in the box

### Base set

- The platform
- Adjustable camera mount x 2
- V-shaped book cradle
- V-shaped transparent platen
- Lighting set
- Glare-prevention shade
- USB hub
- USB numeric keypad
- Software Installation CD
- Printed and electronic documentation

### Optional items

- Digital SLR cameras x 2
- Recommended lenses x 2
- AC Adapters x 2
- AutoSwitch

## Supported Camera Models

- Canon EOS 350D (XT)
- Canon EOS 400D (XTi)
- Canon EOS 450D (XSi)
- Canon EOS 20D
- Canon EOS 30D
- Canon EOS 40D
- Canon EOS 50D
- Canon EOS 5D
- Canon EOS 5D Mark II
- Canon EOS 1D Mark II
- Canon EOS 1D Mark II N
- Canon EOS 1Ds Mark II
- Canon EOS 1D Mark III
- Canon EOS 1Ds Mark III

The information on this brochure is subject to change without notice.  
Please visit [www.atiz.com](http://www.atiz.com) for the most current information.



info@atiz.com • www.atiz.com

### HEADQUARTER

Atiz Innovation Co., Ltd.  
1355-6 Soi Dheparak 8 Dheparak Rd.  
T. Dheparak A. Muang Samuthprakarn  
10270 Thailand  
Phone: +66 2394 0786, +66 2394 1065  
Fax: +66 2755 6055

### NORTH AMERICA

Atiz Innovation, Inc.  
2441 N. Beachwood Dr., #4  
Los Angeles, CA 90068 USA  
Phone: +1 800 501 6035  
Fax: +1 866 895 2691